

Current Sensor

Product Series: STK-616K

Part number: STK-616K-40FC
STK-616K-65FC

Version: Ver 2.2

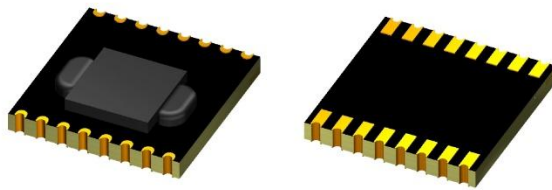

Sinomags Technology Co., Ltd

Web site: www.sinomags.com

CONTENT

1. Description	2
2. Part number definition	3
3. Temperature vs Current	3
4. Electrical data STK-616K-xxFC	4
5. Dimension & Pin definitions without OCD function	5
6. Dimension & Pin definitions with OCD function	6
7. Pin definitions	7
10. Response Time	8
11. Typical Application of STK-616K	9
12. Examples of OCD function	10
13. General information on OCD	11
14. PACKAGE MATERIALS INFORMATION	13

1. Description

The STK-616K series current sensor is based on TMR (tunnel magnetoresistance) technology and open-loop design. It is suitable for DC, AC pulsed and any kind of irregular current measurement under the isolated conditions.

Typical applications

- AC Variable speed drives
- Inverter
- Electric welder power supply
- Switched model power supplies (SMPS)

General parameter

Parameter	Symbol	Unit	Value
Working temperature	T_A	°C	-40 ~ 125
Storage temperature	T_stg	°C	-40 ~ 125
Mass	m	g	0.5

Absolute maximum rating

Parameter	Symbol	Unit	Value
Supply voltage	V _{cc}	V	6
ESD rating (HBM)	U_ESD	kV	4
Junction temperature	T_J	°C	150

Remark: the unrecoverable damage may occur when the product works on the conditions over the absolute maximum ratings. Long-time working on the absolute maximum ratings may cause the degradation on performance and reliability.

Isolation parameter

Parameter	Symbol	Unit	Value	Comment
RMS voltage for AC test 50Hz/1 min	U _d	kV	2	
Impulse withstand voltage 1.2/50μs	Û _w	kV	10	
Clearance distance (pri. -sec)	d _{Cl}	mm	6	Determined by customer's layout
Creepage distance (pri. -sec)	d _{Cp}	mm	6	

Measuring current table

Product	Optimized Range I _{pn} (A)	Sensitivity, (mV/A)	V _{cc} (V)	T(°C)
STK-616K-40FC-1-1.65-E-2-C	±40A	33	3.3V	-40 ~ 125
STK-616K-40FC-1-1.65-E-1-Z	±40A	33	3.3V	-40 ~ 125
STK-616K-65FC-1-1.65-E-2-C	±65A	20	3.3V	-40 ~ 125
STK-616K-40FC-1-1.65-E-2-Z	±40A	33	3.3V	-40 ~ 125
STK-616K-65FC-1-1.65-E-1-Z	±65A	20	3.3V	-40 ~ 125
STK-616K-65FC-1-1.65-E-2-Z	±65A	20	3.3V	-40 ~ 125
STK-616K-40FC-0-1.65	±40A	33	3.3V	-40 ~ 125

2. Part number definition

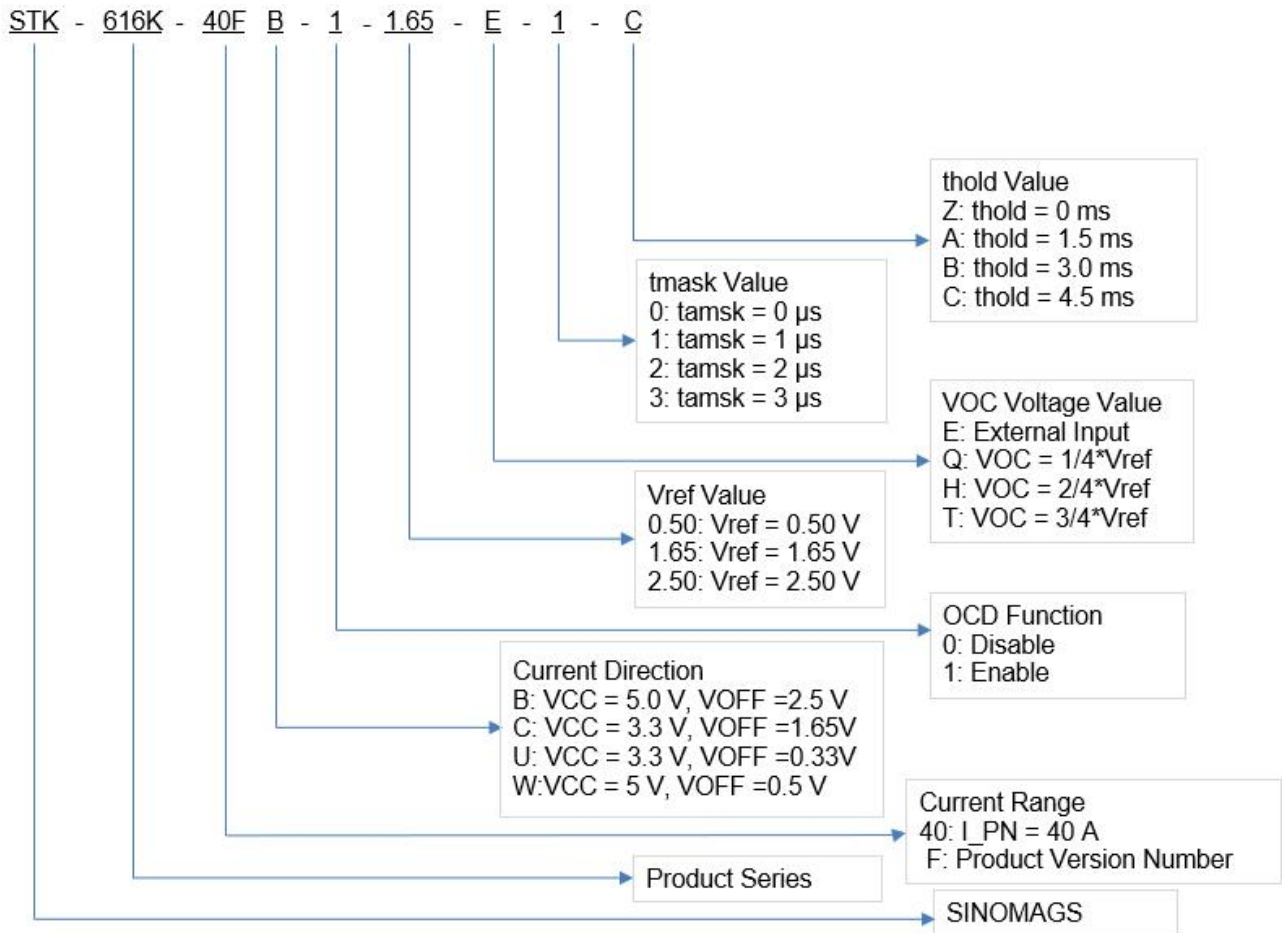

3. Temperature vs Current

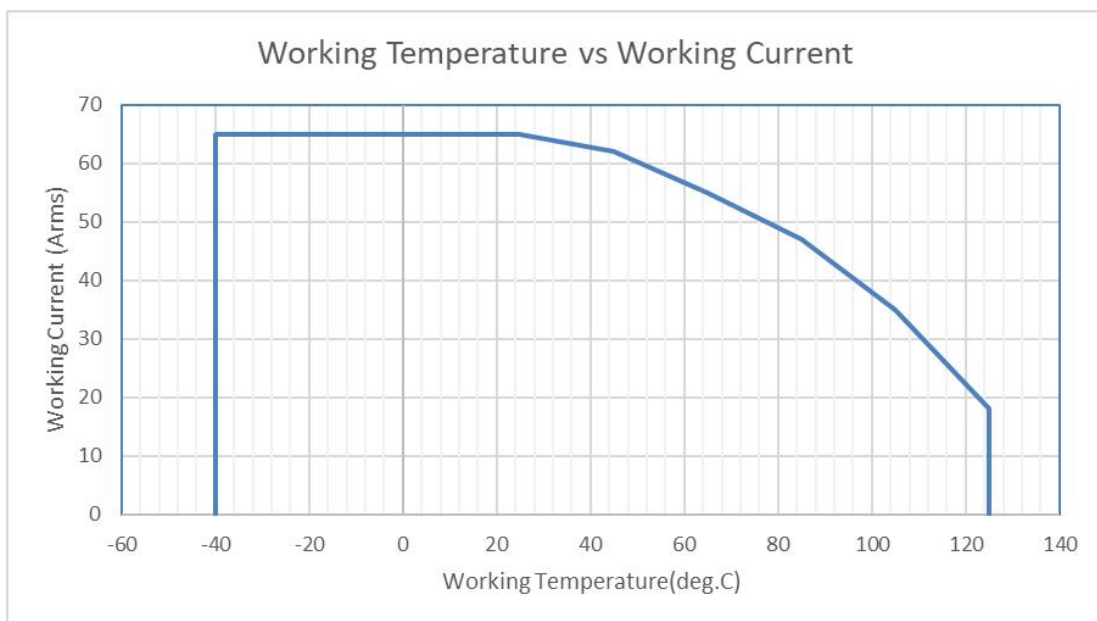

4. Electrical data STK-616K-xxFC

Condition: $T_A = 25^\circ\text{C}$, $V_{CC} = 3.3\text{ V}$

Parameter	Symbol	Unit	Min	Typ	Max	Comment
General parameters						
Primary nominal current	I _{pn}	A	-40		40	STK-616K-40FC
			-65		65	STK-616K-65FC
Supply voltage	V _{cc}	V	3.15	3.3	3.45	
Current consumption	I _{cc}	mA		7	12	
Quiescent voltage	V _{off}	V	1.6	1.65	1.7	
Internal output resistance	R _{out}	Ω	1		30	
Theoretical gain	G _{th}	mV/A		33		STK-616K-40FC
				20		STK-616K-65FC
OCD function (if applicable)						
OCD range	V _{OC}	V	0.3		1.6	
FAULT error		%		5%		% of OCD
OCD Hysteresis	I _{HYS}	%		10%		% of OCD
OCD Fault Mask	t _{mask}	μs		1		0, 1, 2, 3 μs
OCD Fault Mask error	T _{mask_error}	ns		125		
OCD Fault Hold Time	t _{hold}	ms		4.5		0, 1.5, 3, 4.5 ms
Rated linearity error@25°C	Non-L	% I _{pn}		±1.5		±I _{pn}
Accuracy performance						
Delay time	t _{delay}	μs		0.2		@400 kHz
Step response time	t _{res}	μs		0.5		@90% of I _{pn}
Frequency bandwidth	BW	MHz		1		@-3dB
Output voltage noise	V _{noise}	mV _{pp}		20		100 ~ 120 kHz @250 kHz S.R.
Accuracy @ 25°C	X	% I _{pn}		±1.5		@ 0.5*I _{pn}
Thermal drift of G _{th}	Gain _T	% of G _{th}	-1.5		1.5	@ -40~105°C
Thermal drift of V _{off}	V _{off_T}	mV	-15		15	drift related to the value @25°C
Total Accuracy	X _{TRange}	% of I _{pn}	-3		3	

5. Dimension & Pin definitions without OCD function

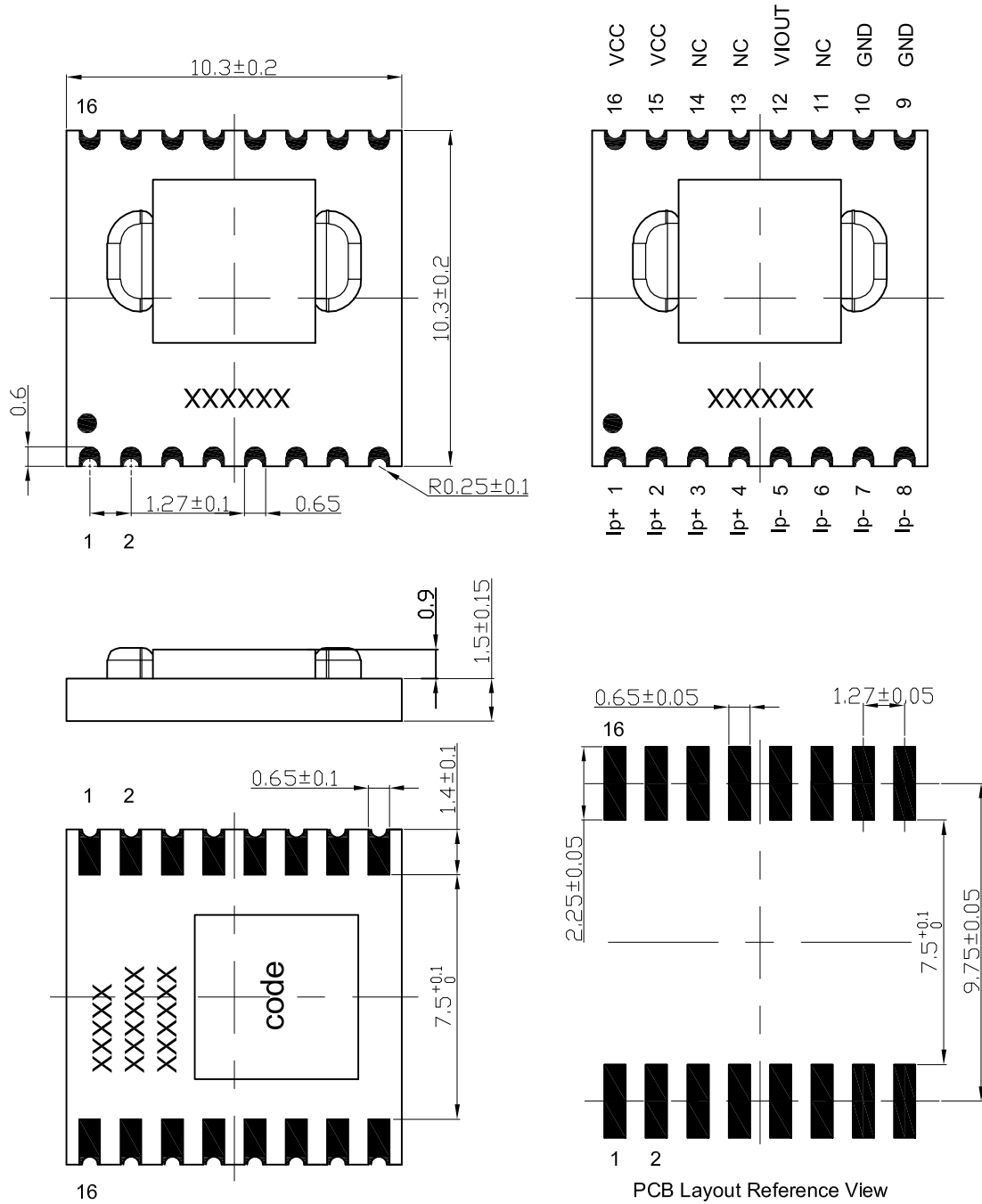

The mark of "KXXFB" on the top surface shows the information on the "Part number": "K" = "STK-616K", "XX" = "Product sensing range", "B" = "Current direction", "F" = "Product Version Number".

6. Dimension & Pin definitions with OCD function

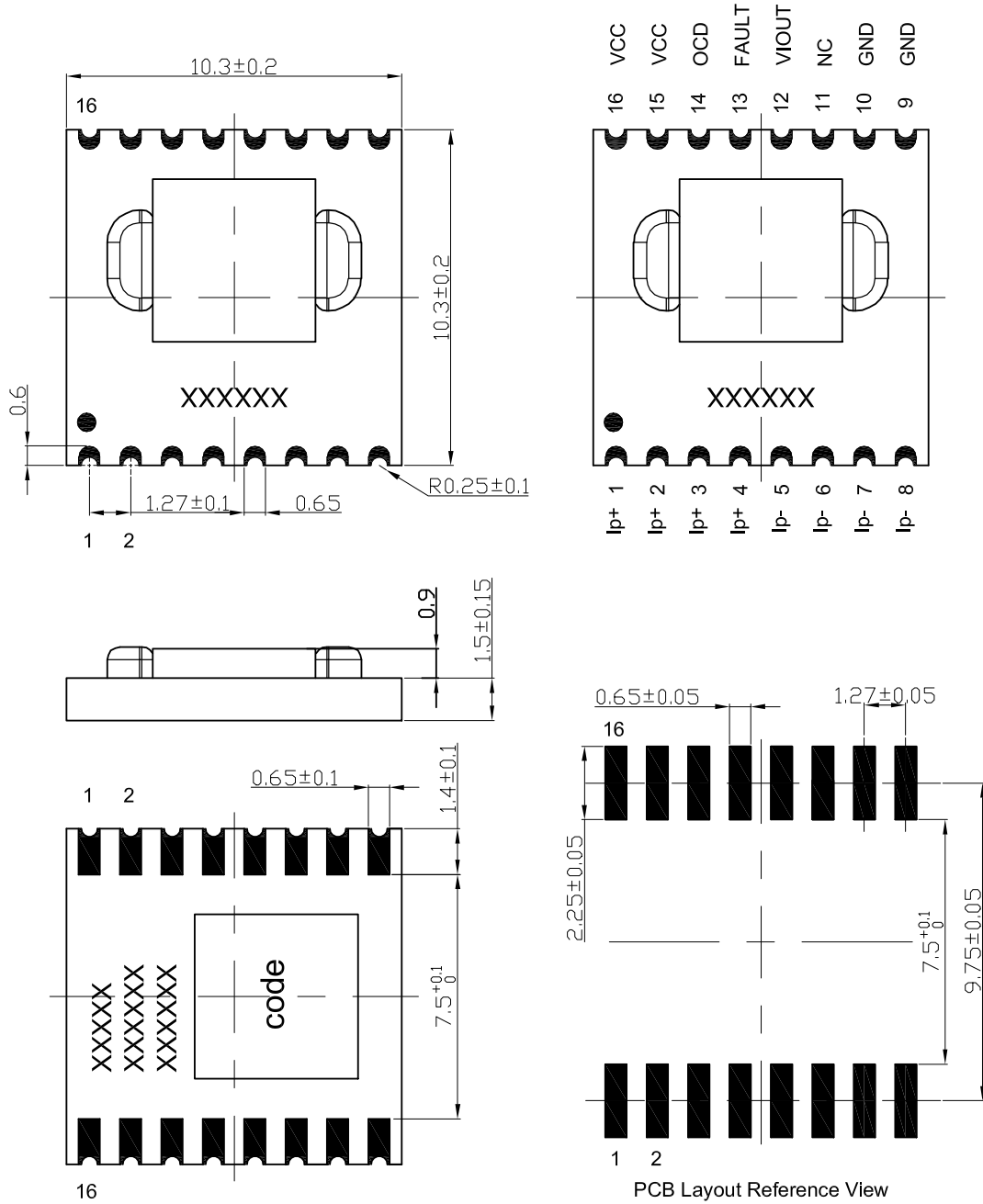

The mark of "KXXFC" on the top surface shows the information on the "Part number": "K" = "STK-616K", "XX" = "Product sensing range", "C" = "Current direction", "F" = "Product Version Number".

7. Pin definitions

PIN	Symbol	Description
1,2,3,4	IP+	Primary conductor pin (+)
5,6,7,8	IP-	Primary conductor pin (-)
9,10	GND	Ground pin (GND)
11	NC	Internal use only
12	VIOUT	Sensor output pin
13	FAULT	Over current detection alarm output, the pin is open leakage output. Normally, the output of fault pin is high level
14	OCD	Over current detection threshold input pin
15,16	VCC	Power supply pin

8. PCB layout recommendation

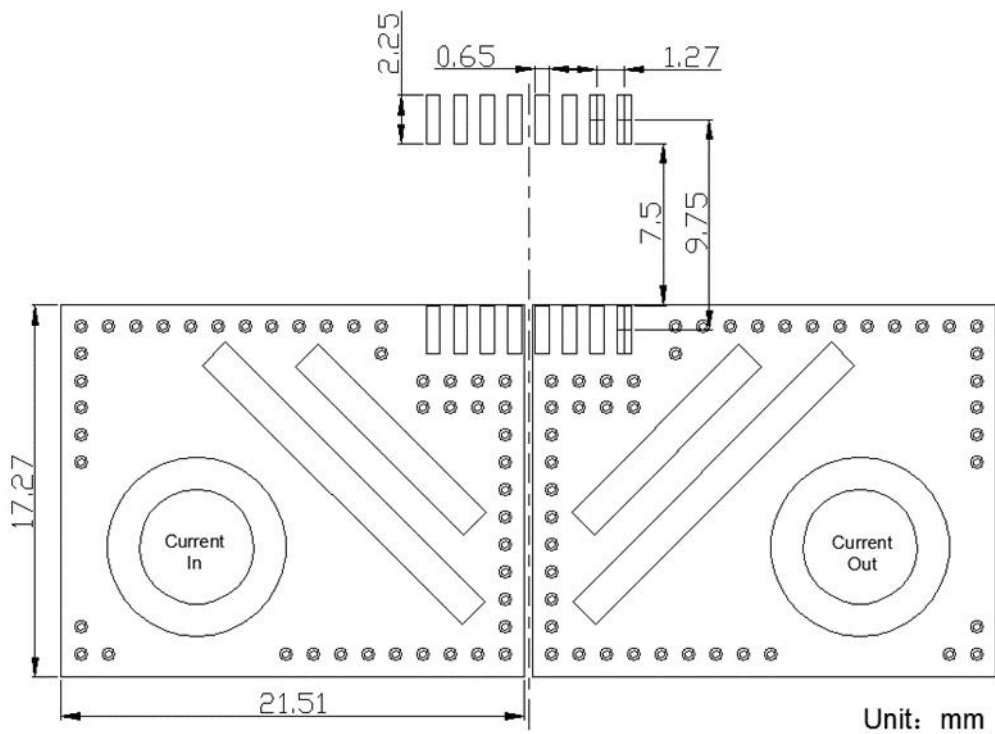

9. Frequency band width

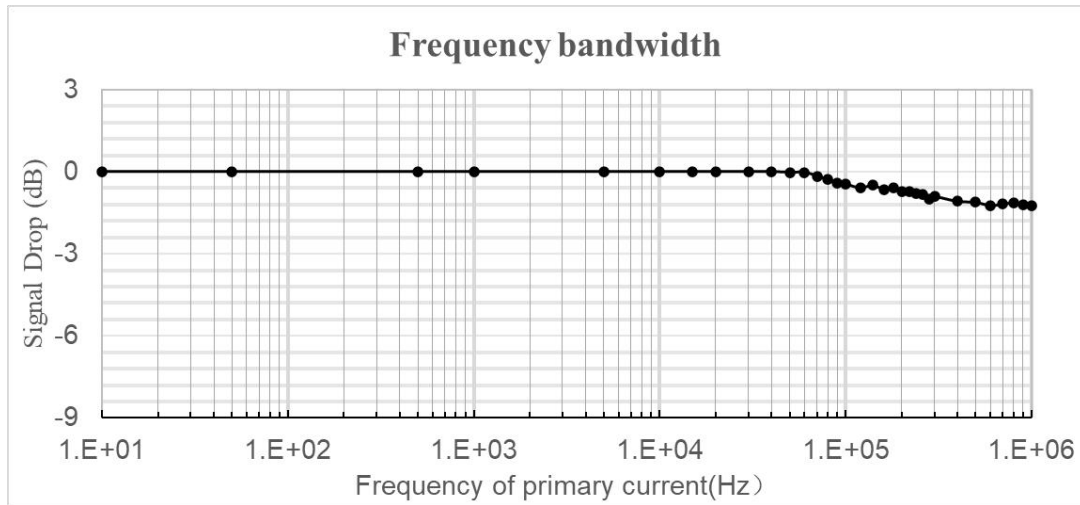

10. Response Time

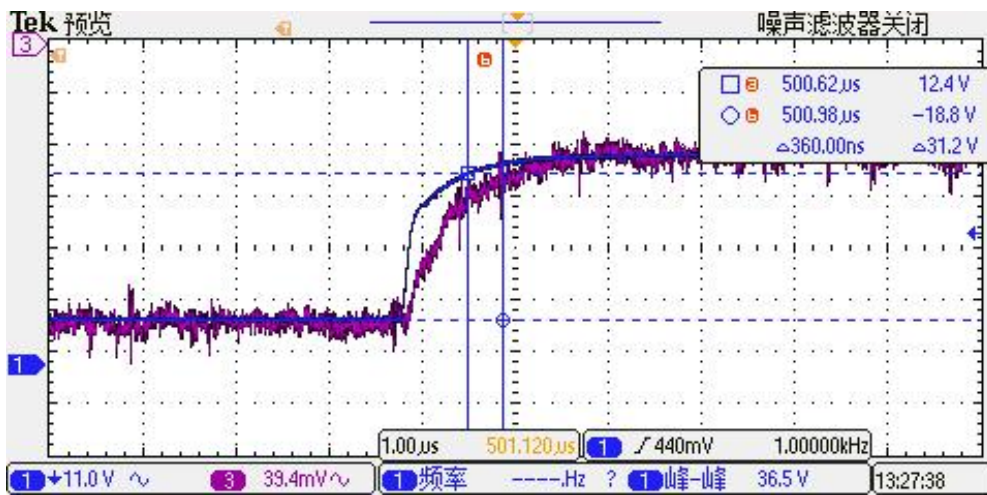

The typical frequency response of STK-616K current sensor. The response time from 90% of the primary current (pink) to 90% of the secondary output is 0.36 μs.

12. Examples of OCD function

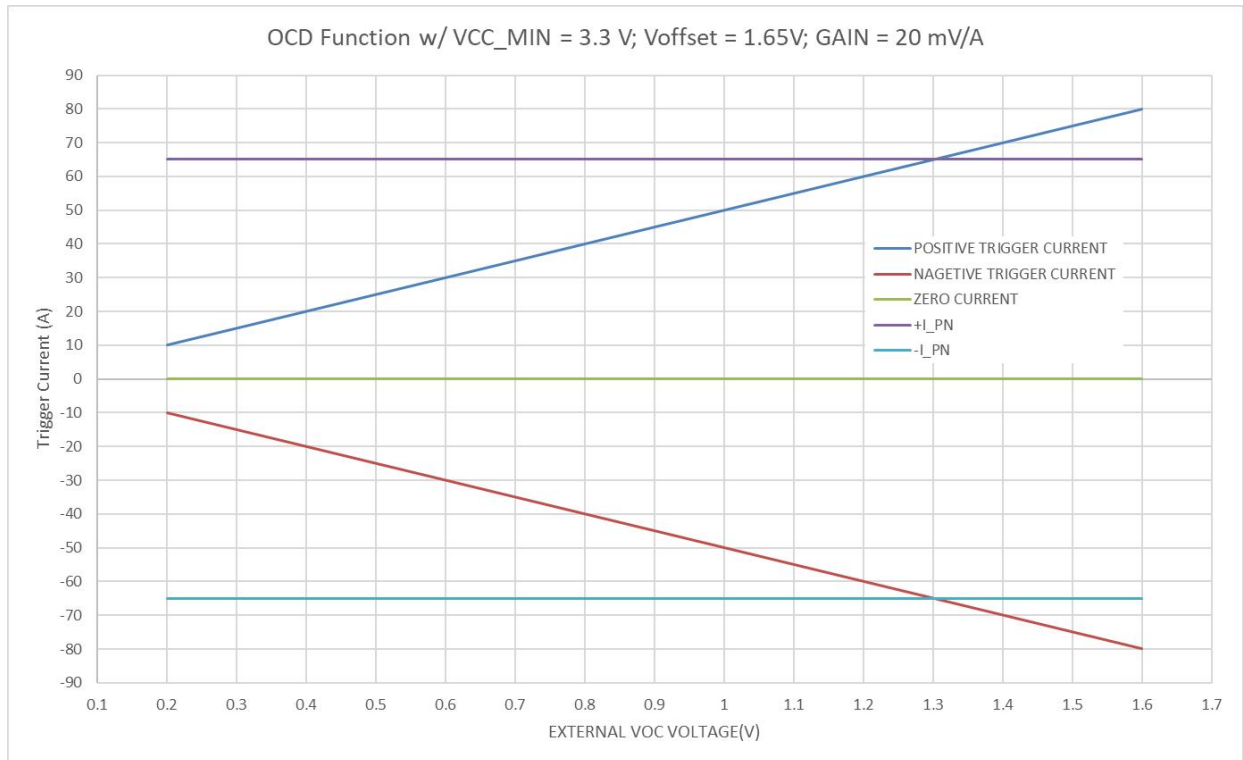

OCD function for STK-616K-65FC

13. General information on OCD

This section describes the general information on OCD function, the specific functions, which are not listed in the section of “electrical data”, can be defined per request.

Since the trigger voltage is set after the second amplifier, the OCD function supports that the trigger current can be higher than I_{pn} . The trigger voltage can be defined:

- a) $V_{ref} = 2.5\text{ V}$
 - a) $0.5\text{ V} \cong VOC \cong V_{cc} - 1.7\text{ V};$
 - b) Trigger voltage = $V_{ref} \pm VOC;$
 - c) Trigger current = $(V_{ref} \pm VOC - V_{off}) / G_{th};$
- b) $V_{ref} = 1.65\text{ V}$
 - a) $0.3\text{ V} \cong VOC \cong V_{cc} - 1.7\text{ V};$
 - b) Trigger voltage = $V_{ref} \pm VOC;$
 - c) Trigger current = $(V_{ref} \pm VOC - V_{off}) / G_{th};$
- c) $V_{ref} = 0.5\text{ V}$
 - a) $0.2\text{ V} \cong VOC \cong 0.5\text{ V};$
 - b) Trigger voltage = $V_{ref} + 8 \cdot VOC;$
 - c) Trigger current = $(V_{ref} + VOC - V_{off}) / G_{th};$

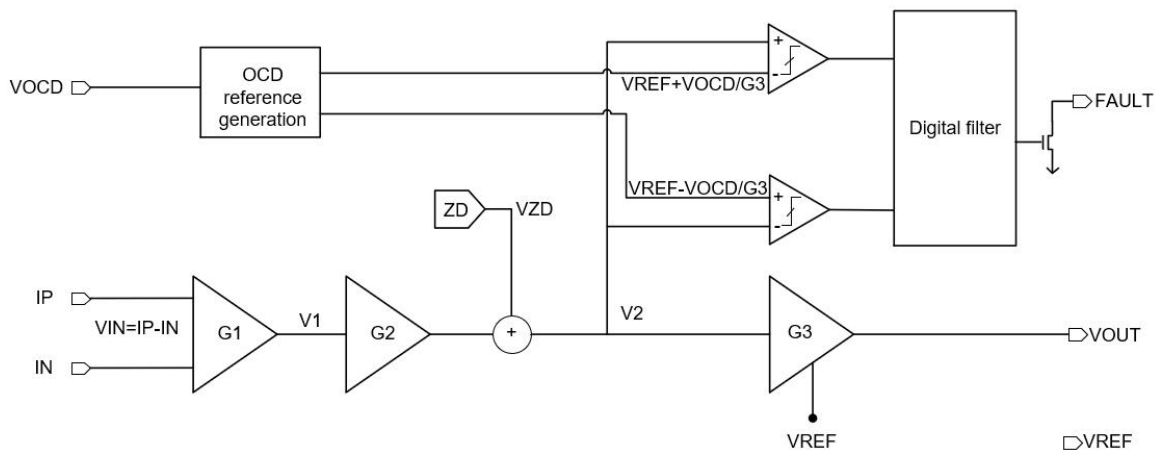

Functional Block Diagram on OCD function when $V_{ref} = 2.5\text{ V}$

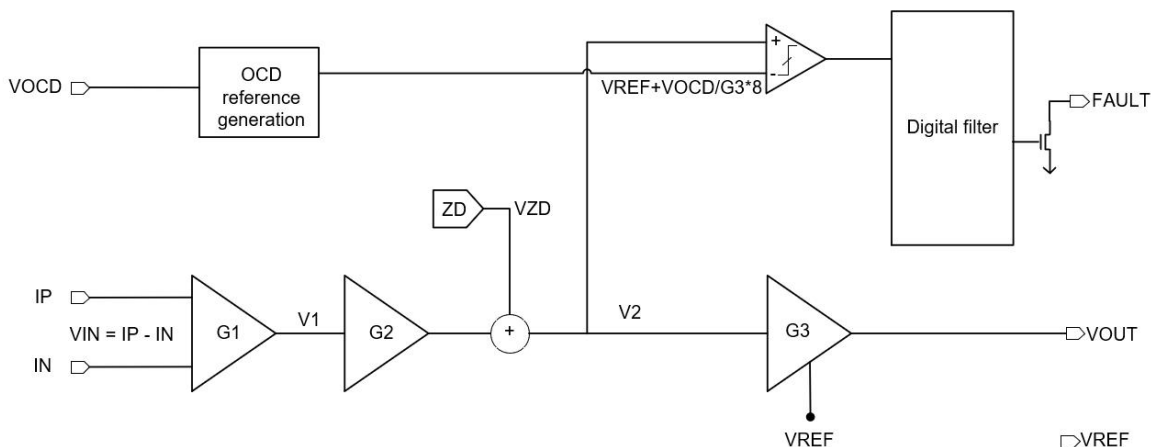

Functional Block Diagram on OCD function when $V_{ref} = 0.5\text{ V}$

With the above definition, below shows the relationship between trigger voltage and the setting of Vcc, VOC.

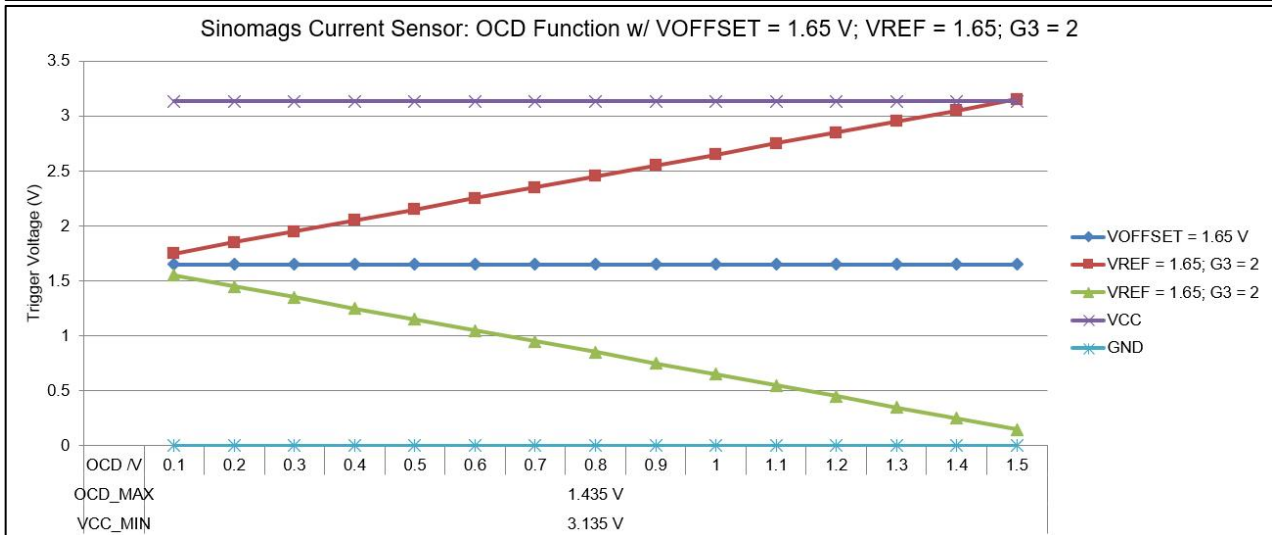
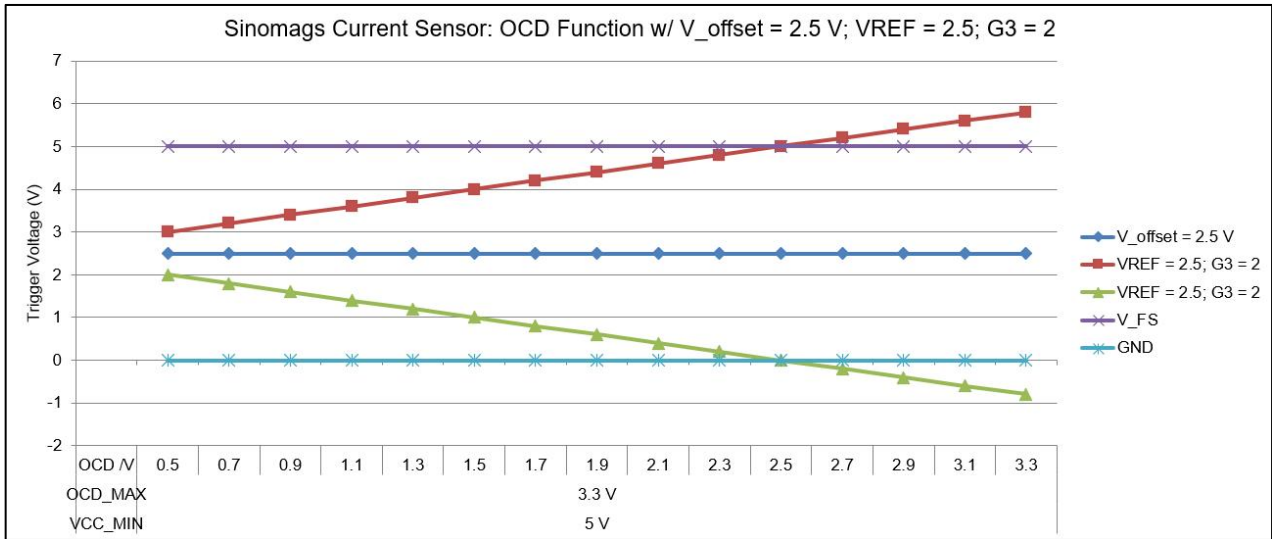

14. PACKAGE MATERIALS INFORMATION

TAPE AND REEL INFORMATION

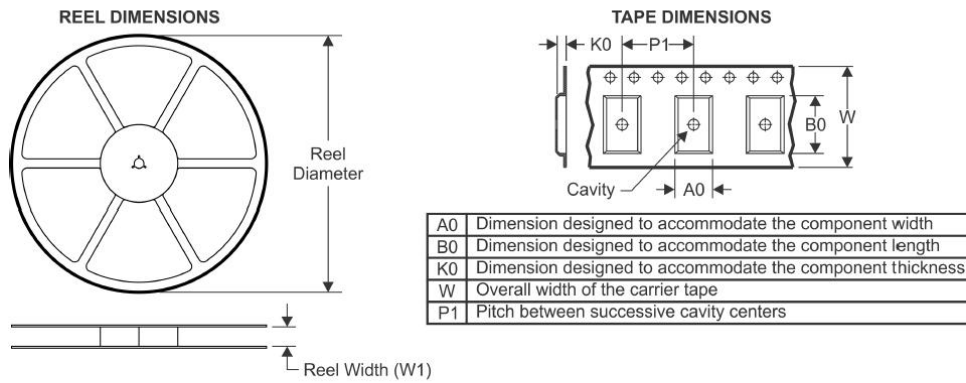

QUADRANT ASSIGNMENTS FOR PIN 1 ORIENTATION IN TAPE

